

Collegare solo le sonde come indicato.
 Se i termostati di massima e di minima non
 impiegati, bisogna cavallottare gli ingressi.
 Idem per il termostato ambiente.

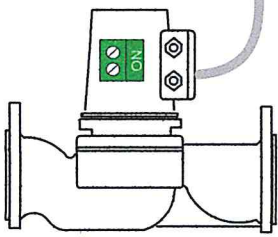
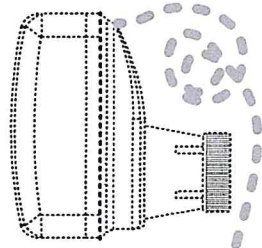
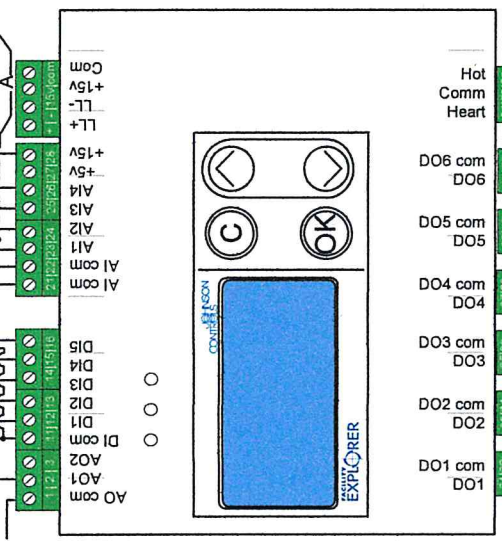
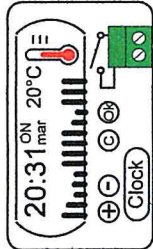
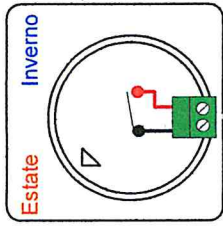
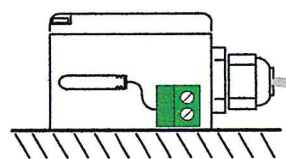
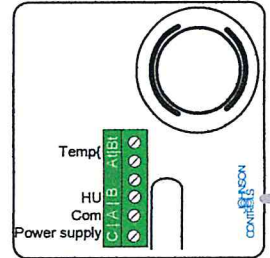

Cablaggio schematico applicativo standard
 controllo pannello radiante

26C30

REV.	1.01
DATA	02-2011